

ZLATA 70 CL

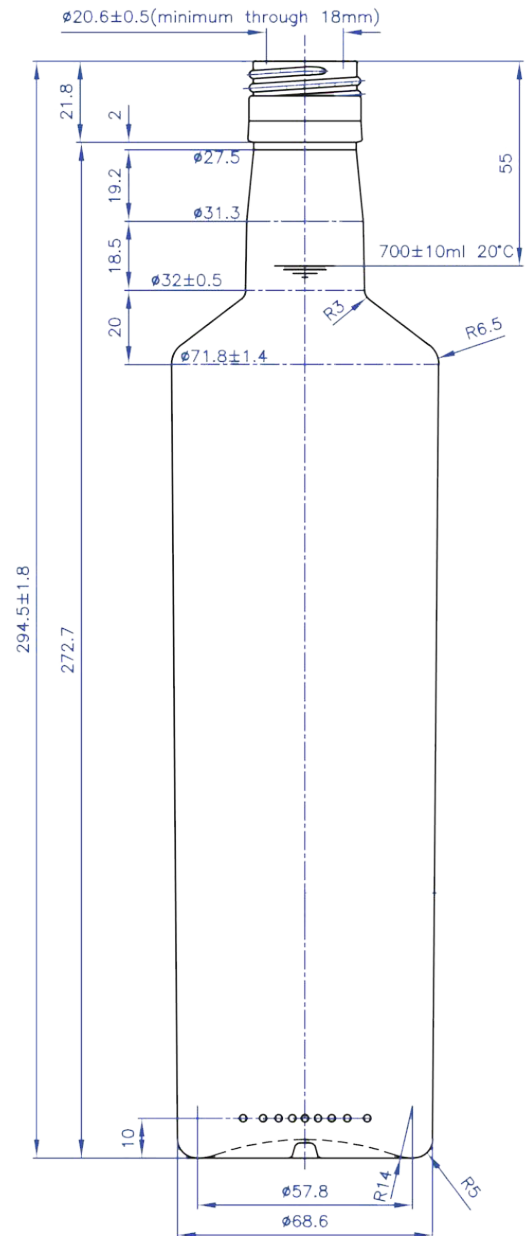
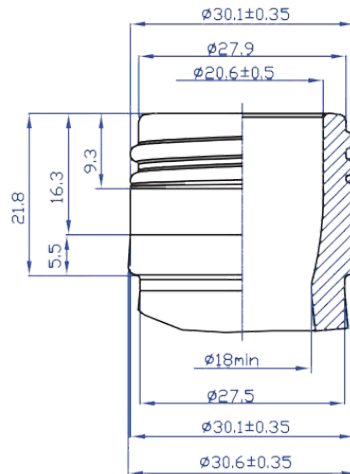

Denominación

Zlata 70 cl

Cap. a verter / Brimfull

720 \pm 10 ml

Cap. de llenado / At fill line

700 \pm 10 ml

Peso / Weight

450 \pm 10 g

Presión Hidrostática

5 bar.

Resistencia Térmica

40° C

Finish

P.P.31.5x44